

Ultimate Light-weight & Compact Size, Meticulous Dedicated Design

KITO ELECTRIC CHAIN HOIST

EQ

Dual Speed Inverter Type
Equipped with
Electronic Overload Protection Device (OLL)
and Friction Clutch



**Cool Design and
Intelligent Function**



Highlighting the Global Industry with Technology Ultimate KITO Electric Chain Hoist EQ Now Released

Dual Speed Inverter Type
Equipped with
Electronic Overload Protection Device (OLL)
and Friction Clutch

KITO ELECTRIC CHAIN HOIST

EQ

125kg-1t



New KITO Electric Chain Hoist EQ maximizes the characteristics of its dual speed inverter.

And we stick with the control design.

Motor-frame integration has materialized an ultimate light-weight, compact size, while maintaining high functions.

Equipped with OLL; the electronic overload protection device and friction clutch to ensure operational safety and environmental friendliness.

Designed light-weight and compact, unique-shape push button switches are easy to grab and operate.

KITO New Electric Chain Hoist is released now.

You can experience the new design!





Integrated body protecting the high performance and high functions

- > Outstanding rigidity, high dust-proofness and water-proofness suitable for severe environments and working conditions
- > No-Load High-Speed Function
- > Simply-structured integrated body with less component parts
- > Dust-proof and jet-proof body (IP55)

Combination of idea and technology materializing light-weight size

Meticulous inverter dedicated design

- >
- > Transformer-free structure based on the inverter DC power
- > Thermal protector-free structure based on the electronic thermal system

Double safety mechanism preventing the accident at the occurrence of abnormal load

Equipped with a friction clutch and electronic overload limiter

- > The friction clutch prevents breakage of the hoist body and load chain at the occurrence of abnormal load such as an overload and lifting an anchored object.
- > The electronic overload limiter detects an overload with the inverter and stops operation immediately.

Shutting off the current to the motor at the time of excessive lifting/lowering to prevent an accident

- > The upper-lower limit switch prevents damage on the hoist body and load chain at the time of excessive lifting/lowering.
- > Simply-structured upper-lower limit switch considering reduction of dead space

Meticulous long-life design

- > Motor with an ingenious external cooling fan
- > Oil bath lubrication type gear box
- > Optimally shaped motor frame fins and fan cover
- > Intermittent rating 40/20% ED

Suitable for severe environments and working conditions

Simple design with Grade M6

World-class KITO original chain

- Superstrong nickel-plated load chain
- > Highly enhanced fatigue and wear resistance due to ingenious technology
- > Special alloy steel quenched chain with high strength, durability and accuracy

Visual indication of maintenance timing

- > Capable of showing the number of starts of the hoist and the hoist's total on-time in the Data Display, allowing maintenance and inspection according to the frequency of use.
- > Capable of controlling the inspection and replacement timings of component parts, etc. to suggest a maintenance plan for safety operation.

Shutting off the motor circuit in case of emergency

- > Capable of shutting off the motor circuit at hand by pressing the emergency stop button.
- > Originally designed easy-to-operate push button switch based on ergonomics
- > 24 V DC operating voltage for higher safety

Higher work efficiency of the inspector

Higher maintainability

- > Easy removal of a suspension eye by installing a connecting shaft at the upper part of the body
- > Centralized control by the inverter minimizes the number of electric parts and equipment and minimizes replacement parts.

Environmentally friendly

- > Free from 15 environmentally hazardous substances specified by KITO, including 6 European RoHS directive substances
- > Lower noise during operation and braking due to a 4-pole motor and pull-rotor brake

C o n t e n t s

4 EQ Electric Chain Hoist

- Structure and Features

5 Smooth & Ergonomic Operation

- Inverter
- Push button control

- Electronic overload limiter & friction clutch & upper-lower limit switch
- Electronic thermal protector
- Pull rotor type drum brake
- Emergency stop

Easier Maintenance

- Connecting shaft & suspension-eye
- CH (counter hour) meter

7 Enhanced Durability

- High end duty rating
- Unique motor frame fins & fan cover
- Load chain

Environmentally Friendly

- No hazardous substances
- Lower noise

8 EQ Outline

9 EQ Electric Chain Hoist Lineup

Trolleys

- Motorized Trolley MR2Q
- Plain Trolley TSP

Lifting & Traversing Speed

- EQ
- MR2Q

10 Product Code Chain Containers Product Configurations

11 Hoist Classifications

- ISO/JIS
- FEM
- ASME HST

12 EQ

- With Suspension Eye (Specifications/ Dimensions)
- Suspension Eye & Bottom Hook Dimensions**

13 EQM

- With Motorized Trolley (Specifications/ Dimensions)

14 EQSP

- With Plain Trolley (Specifications/ Dimensions)

15 Technical Documents

- Electric Chain Hoist (EQM) Rated Currents
- Power Supply Cable Allowable Lengths (EQ + MR2Q)

Structure and Features

Safe and Durable Structure with High Maintainability

Environmentally friendly

KITO-specified 15 environmentally hazardous substances, including 6 European RoHS directive substances, are not used. Noise during operation and braking has been reduced by using a 4-pole motor and pull-rotor brake.

Safe and reliable brake structure

A drum brake stops a load unflinching.

Temperature rise inhibition by the cooling fan

The fan attached to the end of the motor shaft feeds the cooling air to the body, motor cover and regenerative resistors to prevent the temperature rise of the hoist body during operation.

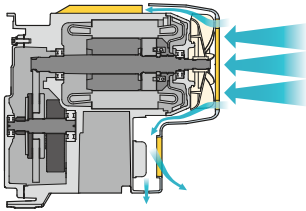

Suspension eye connectable to any part

Use of a suspension eye allows applications to various usages.

Connecting Shaft

An access section to the connecting shaft is installed outside the body so as to easily remove the suspension eye.

Aluminum die-cast body

The body and motor frame have been integrated to make the entire body tough and compact.

Enclosure

Dust-protected and jet-protected (IP55)



Low-noise gear mechanism

Use of helical gears greatly reduces operating noise.

Gear box

Lubrication by the oil bath enhances wear resistance of the gears as well as a cooling effect.

Chain container

Durable plastic containers as standard.

Nickel-plated chain

KITO's original chain with high toughness and fatigue strength has been plated with nickel. It has excellent wear resistance.

World-class superstrong load chain

This is KITO's original special alloy steel quenched chain developed by long years of research. The load chain is produced through the fully automated production facilities from material-loading to completion under high quality control. It has the hard surface to enhance wear resistance and is well-balanced between its strength and toughness in the core section. It is excellent in strength, durability and accuracy.

Hook with skid preventive hook latch (Bearing contained)

Even if overloaded, the bottom hook is only gradually deformed and does not break. A notched skid-free hook latch has enhanced its durability.

Thin, light-weight push button switch

Newly developed minute current type push button switch responds to the 24 V DC inverter power. Compact design for easy grasp. * 3 and 5 buttons only

Inverter incorporated functions

The CH meter (counter/hour meter) function incorporated in the inverter allows you to check the number of starts of the hoist and the hoist's total on-time, and carry out maintenance and inspection according to the frequency of use. An electronic overload limiter is provided to make the inverter detect an overload and stop lifting operation. The inverter detects the load condition, and if there is no load, a no-load high speed function is activated to automatically switch to high speed operation.

Friction clutch

Originally developed as an emergency overload protection by KITO to slip the force from the motor in such lifting an anchored object.



Upper-lower limit switch

Triple safety mechanism combined with the friction clutch and electronic OLL. The circuit is shut off at the time of excessive lifting and lowering. * This is for emergency. Do not use it regularly.



Chain guide

KITO's uniquely-structured for smooth chain-feeding.



Smooth & Ergonomic Operation

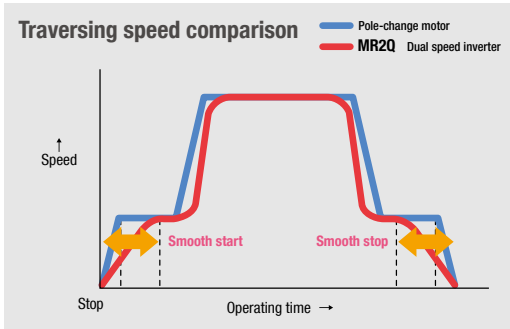
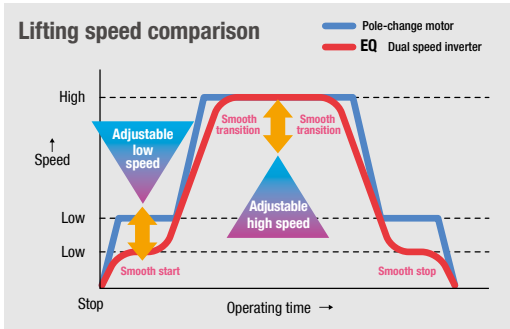

Accelerating and decelerating time in addition to speed are adjustable for dual speed inverter trolley.

Inverter

smooth transitional speed

The dual speed inverter delivers smoother movement than the pole change motor, reducing load swing. The high to low speed ratio can be set to a large value. This results in smooth starts, improved low speed stops, and improved positioning accuracy. The standard speed ratio is 6:1.

A No-load High-Speed Function is equipped as standard feature, allowing its hoisting speed, 1.3 times faster during no-load operation. When the no-load condition is detected by the inverter, this function is activated automatically to switch to high speed operation, leading to improving the work efficiency with ease and safety. This function is easily activated (ON/OFF) with the push button control.

EQ/MR2Q inverter unit is well-customized for lifting/traversing applications including exclusive software with optimum control and is also provided with measures against impact and heat which were verified through long run tests.



Push button control original design

The push button control is designed in an ergonomic shape that is operator friendly. Seeking ease of operation and universal design, KITO's original push button control is designed and manufactured based on trial and error repeated many times, in particular, upgrading prototypes and evaluation from an enduser point of view especially with respect to unit strength.

Contoured to comfortably fit into your hand. The button has a light operating sensation which responds to fine adjustments in pressure. The pressing stroke is short. The operator, therefore, will not become fatigued after long-periods of operation.





Electronic overload limiter & friction clutch & upper-lower limit switch **triple safety**

Maintaining safety is the most important task for lifting equipment, and is essential for stable operation. To ensure safety, KITO utilizes a triple safety mechanism consisting of an originally developed electronic overload limiter and friction clutch and upper-lower limit switch. When the inverter detects an overload, the electronic overload limiter turns off the power to the motor to stop lifting the load.

The friction clutch is an emergency overload protection device that idles the motor when subjected to an excessive load over the rated capacity. Friction clutch performance is not easily compromised with changes in the surrounding temperature. In the case of irregular loading, this operates in advance to prevent the hoist body or load chain from being damaged.



In the event that a load is lifted or lowered excessively, the limit switch stops the motor, preventing hoist or load chain damage. (Not regular use)



Electronic thermal protector

To prevent the motor from burning out due to excessive usage, a standard thermal protector is installed in the inverter.

Pull rotor type drum brake

With a rotor and pull rotor incorporated in the motor, this is a cone type drum brake which is released at the time of operation. When the power is shut off, the brake is activated, ensuring safety.

Emergency stop

The emergency stop, provided as standard, allows the motor power to be disconnected in an emergency without cutting off the main power supply.



Easier Maintenance

Connecting shaft & suspension-eye

The connecting shaft mounted on the outside of the EQ. This allows a suspension-eye to be attached or removed with ease.

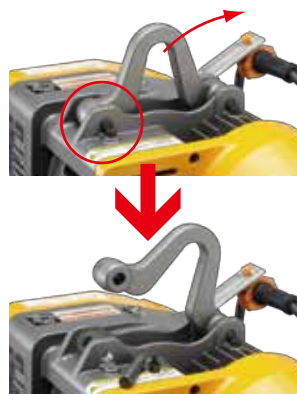

CH (counter hour) meter

As a standard feature, the hoist's total on-time and the number of moving starts are shown on the Data Display of the Inverter. This enables the user to carry out maintenance based upon the frequency of use. By maintaining a history of the CH meter data, the inspection periods and replacement periods for gear oil, brakes and load chains can be efficiently controlled, allowing the equipment to be used with confidence.



Enhanced Durability

High end duty rating

The EQ achieves M6(ISO)/3m(FEM) class (refer to section of "Hoist Classifications"), with a duty cycle of 40/20% ED. Supporting use in the most demanding environments and conditions, this long service life hoist is a heavy-duty product which is also applicable to high frequency or long lift operations.

The gearbox is lubricated in an oil bath. As a result of this, wear and tear has been improved and cooling has also been enhanced at the same time.

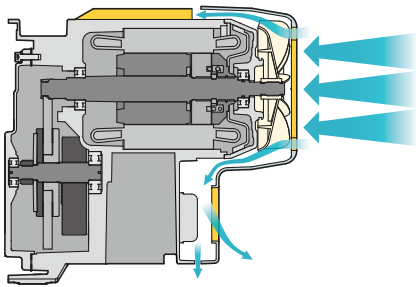

Unique motor frame fins & fan cover

A unique fan-cooled motor with motor frame fins and a fan cover have been configured into a purpose built design. This design produces a much quieter motor unit as well as enhanced fan cooling capabilities.

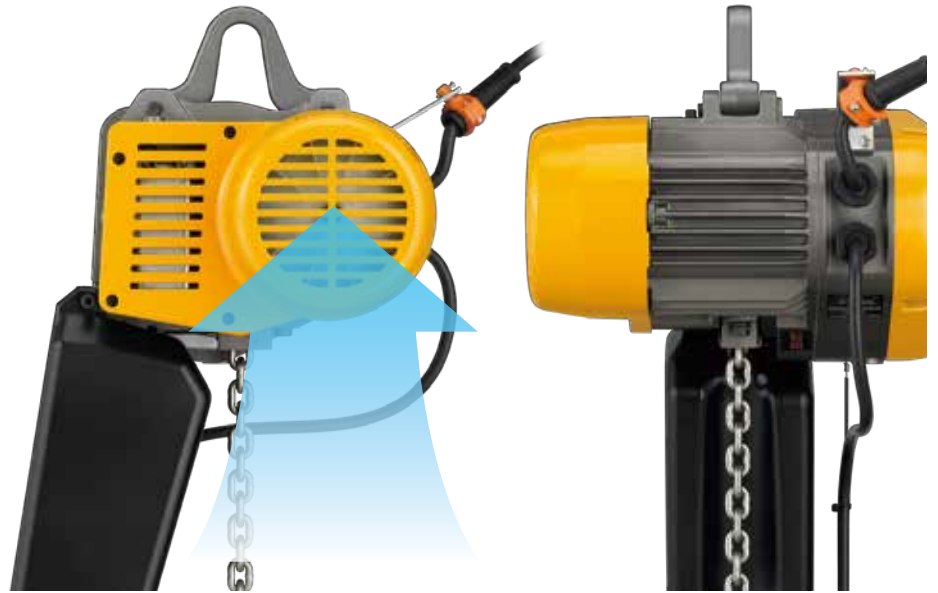

Load chain **super strength**

KITO's world class original super-strength nickel-plated load chain certified by German Institute, uses unique technology to greatly increase resistance to fatigue and wear.

At KITO, testing is continuously being carried out regarding the load chain fatigue, wear, tensile strength, and environment. KITO takes pride in manufacturing load chains that have strength, durability and accuracy for utilization in the product.



Environmentally Friendly

No hazardous substances

As an environmental measure, several environmentally hazardous substances specified by KITO, including 6 European RoHS directive substances, are not used.

Lower noise

The utilization of the inverter, 4-pole motor as well as the drum brake, reduces the noise during operation and braking.



Rated capacity:	125kg-1t (Dual speed)
Voltage:	200-230V 50/60Hz 380-460V 50/60Hz
Control voltage:	DC 24V
Duty rating:	40/20% ED
Classification:	1t: M5 (ISO/JIS), 2m (FEM), H4 (ASME) 125-500kg: M6 (ISO/JIS), 3m (FEM), H4 (ASME)
Motor insulation:	Class B
Enclosure:	Hoist body: IP55, Push button control: IP65
Suspension varieties:	Manual trolley, motorized trolley
Operating temperature:	-20 - +40°C (-4 - +104°F)
Operating humidity:	85%RH or less
Noise level:	EQ,dual speed VFD model 80dB or less (A scale: measured at 1m away from the Electric chain hoist) MR2Q 85dB or less (A scale: measured at 1m away from the Electric chain hoist)
Sound power level:	MR2Q 96dB or less (A scale)



Type	Lifting speed	Capacity			
		125kg	250kg	500kg	1t
Suspension Eye EQ		●	●	●	●
With Motorized Trolley EQM	Dual Speed Inverter	●	●	●	●
With Plain Trolley EQSP		●	●	●	●

KITO will not be held liable for any malfunction, lack of performance or accident if the product is being used in conjunction with any other equipment.
If the product is to be used for unintended purposes, please confirm with your dealer in advance.

Trolleys

Motorized Trolley MR2Q

Bearing built-in side rollers provide smooth running through the minimum radius curve and excellent traversing performance with preventive derailment.

Features

- Simple gear box construction
- Speed variations
- Dual Speed

Plain & Geared Trolley

- Designed to provide smooth and easy traversing.
- Lugs provide protection from striking damage against rail stoppers, and from falling off the rail.
- Wheel flanges also prevent derailment.

Plain Trolley TSP

Designed for light load manual applications (125kg-1t)

Motorized Trolley MR2Q



125kg-1t

Plain Trolley TSP



125kg-1t

Lifting & Traversing Speed

Capacity	50/60Hz			
	High	Low	Adjustable Range	No-Load High-Speed
125kg	17.0	2.8	2.8-17.0	22.1
250kg	10.0	1.7	1.7-10.0	13.0
500kg	7.6	1.3	1.3-7.6	9.9
1t	7.1	1.2	1.2-7.1	9.2

(m/min)

Capacity	50/60Hz		
	High	Low	Adjustable Range
125kg-1t	24	4	2.4-24

(m/min)

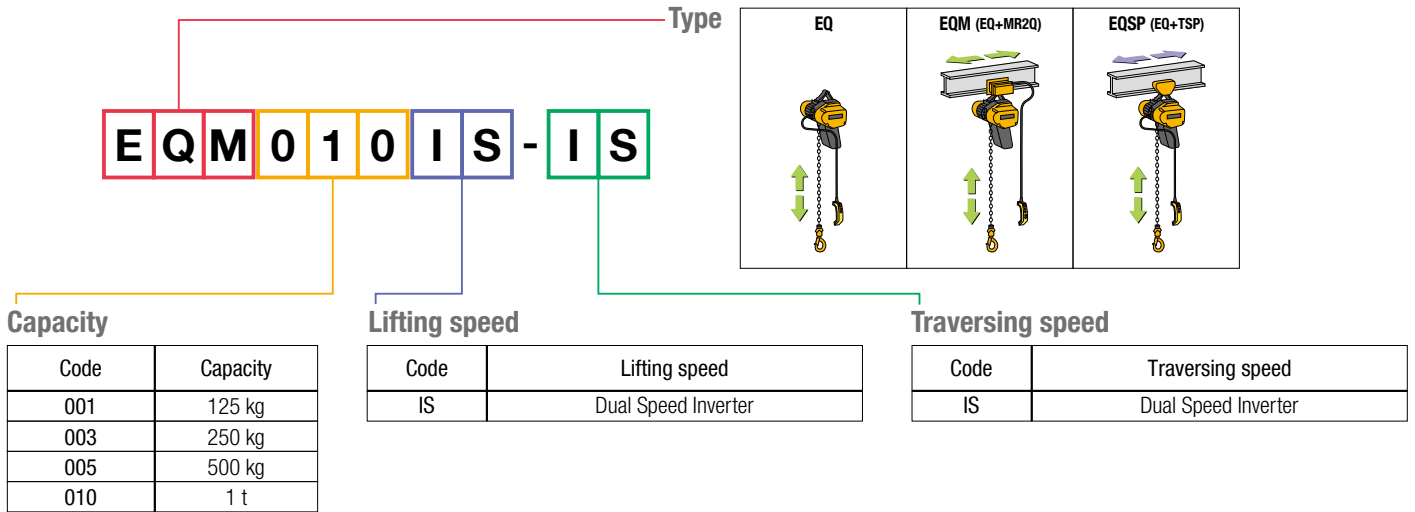

Ex. for EQM010IS-IS, the electric chain hoist bears "EQ010IS" as a product code and the motorized trolley "MR2Q010IS".

Chain Containers

Type of containers



Product code	Body	≤6m	6.1 ≤15m
EQ001IS	C		
EQ003IS			
EQ005IS			
EQ010IS	D		-

Only Plastic Container is available for EQ010IS.

Product Configurations

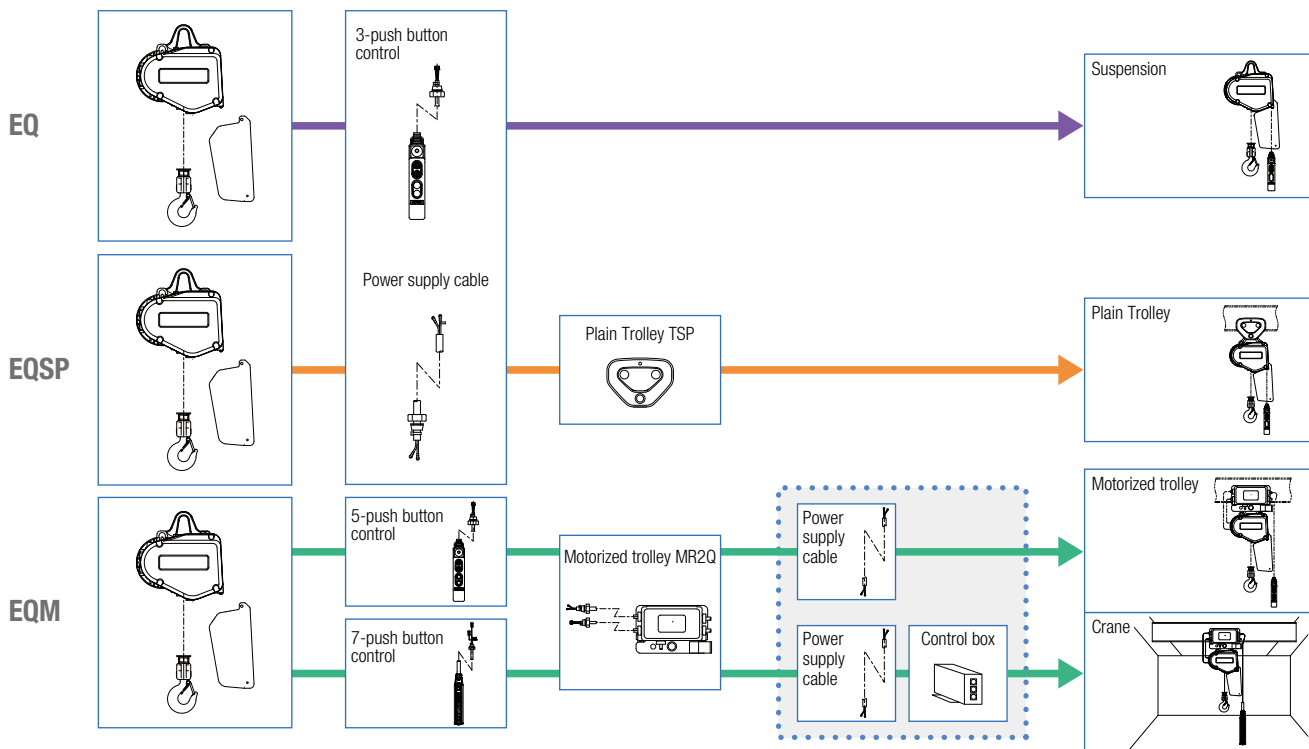

Hoist Classifications

ISO/JIS

State of loading		Total duration of use (h)							
		200	400	800	1600	3200	6300	12500	z
Light	Mechanisms subjected very rarely to the maximum load and, normally, to light loads	–	–	M1	M2	M3	M4	M5	M6
Moderate	Mechanisms subjected fairly frequently to the maximum load but, normally, to rather moderate loads	–	M1	M2	M3	M4	M5	M6	–
Heavy	Mechanisms subjected frequently to the maximum load and, normally, to loads of heavy magnitude	M1	M2	M3	M4	M5	M6	–	–
Very heavy	Mechanisms subjected regularly to the maximum load	M2	M3	M4	M5	M6	–	–	–

This classification refers to ISO 4301-1 and applies to the mechanical components including gears and bearings except for consumable parts.

FEM Relation between ISO-and FEM-Denominations

1 D _m	1 C _m	1 B _m	1 A _m	2 m	3 m	4 m	5 m
M 1	M 2	M 3	M 4	M 5	M 6	M 7	M 8

Load spectrum	Cubic mean value	Class of operation time									
		V 0.06	V 0.02	V 0.25	V 0.5	V 1	V 2	V 3	V 4	V 5	
		T 0	T 1	T 2	T 3	T 4	T 5	T 6	T 7	T 8	
		Average operating time per day in hours									
		≤0.12	≤0.25	≤0.5	≤1	≤2	≤4	≤8	≤16	>16	
1 L1	K≤0.50	–	–	1 D _m	1 C _m	1 B _m	1 A _m	2 m	3 m	4 m	
2 L2	0.50<K≤0.63	–	1 D _m	1 C _m	1 B _m	1 A _m	2 m	3 m	4 m	5 m	
3 L3	0.63<K≤0.80	1 D _m	1 C _m	1 B _m	1 A _m	2 m	3 m	4 m	5 m	–	
4 L4	0.80<K≤1.00	1 C _m	1 B _m	1 A _m	2 m	3 m	4 m	5 m	–	–	

Class of operating time		Average operating time per day (in hours)	Calculated total operating time (in hours)
V0.06	T0	≤0.12	200
V0.12	T1	≤0.25	400
V0.25	T2	≤0.5	800
V0.5	T3	≤1	1,600
V1	T4	≤2	3,200
V2	T5	≤4	6,300
V3	T6	≤8	12,500
V4	T7	≤16	25,000
V5	T8	>16	50,000

The grade symbols are identical to those of FEM 9.511. (Rules for Design of Serial Lifting Equipment: Classification of Mechanisms)

ASME HST

Hoist duty class	Typical areas of application	Operation time ratings at K=0.65			
		Uniformly distributed work periods		Infrequent work periods	
		Max. on time, min/ hr	Max. No. starts/ hr	Max. on time from cold start, min	Max. No. of starts
H2	Light machine shop fabricating, service, and maintenance; loads and utilization randomly distributed; rated loads infrequently handled	7.6 (12.5%)	75	15	100
H3	General machine shop fabricating, assembly, storage, and warehousing; loads and utilization randomly distributed	15 (25%)	150	30	200
H4	High volume handling in steel warehouses, machine shops, fabricating plants and mills, and foundries; manual or automatic cycling operations in heat treating and plating; loads at or near rated load frequently handled	30 (50%)	300	30	300

The grade symbols are identical to those of ASME HST-1M. (Performance standard for Electric Chain Hoist)

With Suspension Eye

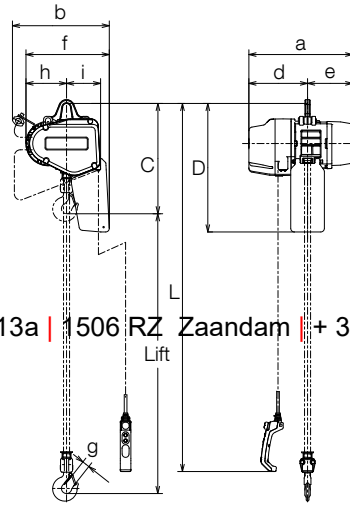

- Standard length of power supply cable is five meters.
- Optional length of lift, push button cord and power supply cable besides standard is available on your request.
- Extending the load chain is prohibited with additional links.

Louis Reyners BV | Symon Spiersweg 13a | 1506 RZ Zaandam | + 31 (0) 75 650 47 50 | info@lr.nl | www.LR.nl

Specifications

Capacity (t)	Product Code	Hoist Body	Standard Lift (m)	Push Button Cord L (m)	Lifting Motor		Lifting Speed (m/min)*			No load High speed	Load Chain		Classification ISO/FEM/ASME	Test Load (t)	Net Weight (kg)	Additional Weight per 1m Lift (kg)
					Output (kW)	Rating (%ED)	50/60Hz				Diameter (mm)	Chain Falls				
							High	Low	No load High speed							
125kg	EQ001IS	C	3	2.5	0.5	40/20	17.0	2.8	22.1	22.1	5.6	x 1	M6/3m/H4	156kg	30	0.71
250kg	EQ003IS						10.0	1.7	13.0	13.0				625kg		
500kg	EQ005IS						7.6	1.3	9.9	9.9				625kg		
1	EQ010IS	D			1.5		7.1	1.2	9.2	9.2	7.1	x 1	M5/2m/H4	1.25	42	1.14

Note: The high speed is preset to the maximum speed in KITO factory. The speeds are adjustable between High and Low.

Dimensions (mm)

Capacity (t)	Product Code	Headroom C	D	a	b	d	e	f	g	h	i
125kg	EQ001IS	395									
250kg	EQ003IS		485	417	367	230	187	298	27	137	128
500kg	EQ005IS		410								
1	EQ010IS	465	535	433	403	245	188	332	31	154	142

Suspension Eye & Bottom Hook Dimensions (mm)

Capacity (t)	Product Code	Suspension Eye								Bottom Hook					
		a	b	R	i	k	j	m	n	D	g	h	f	e	c
125kg	EQ001IS	139.6	67.5	16.5	8	12.2	16	16	33	35.5	27	17.5	23.5	28	17.5
250kg	EQ003IS														
500kg	EQ005IS														
1	EQ010IS	153.6	71		12.3			22	34	42.5	31	22.5	31	36.5	22.5

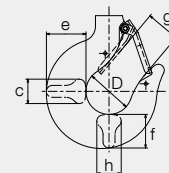
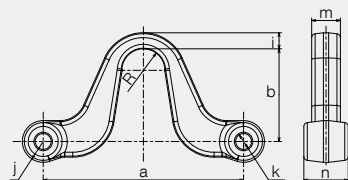

With Motorized Trolley

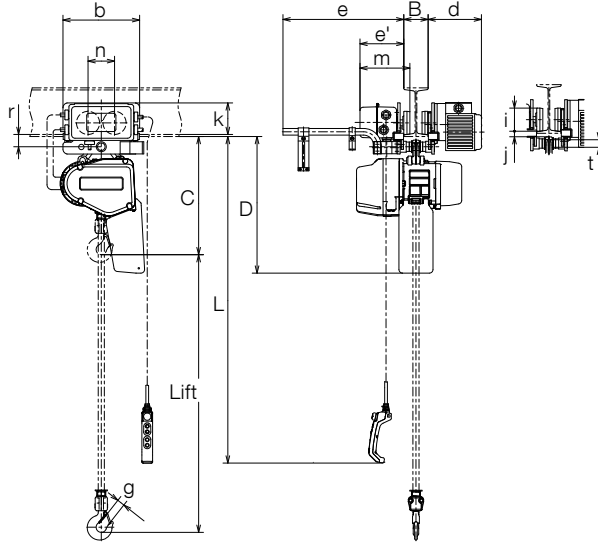

- Standard length of power supply cable is ten meters.
- Optional length of lift, push button cord and power supply cable besides standard is available on your request.
- Extending the load chain is prohibited with additional links.

Specifications

Capacity (t)	Product Code	EQ										MR2Q				Test Load (t)	Net Weight (kg)	Additional Weight per 1m Lift (kg)			
		Hoist Body	Standard Lift (m)	Push Button Cord L (m)	Lifting Motor		Lifting Speed (m/min)*			Load Chain Diameter (mm) x Chain Falls	Classification ISO/FEM /ASME	Traversing Motor		Traversing Speed (m/min)*					Flange Width B (mm)		Min. Radius Curve (mm)
					Output (kW)	Rating (%ED)	50/60Hz		Output (kW)			Rating (%ED)	50/60Hz		Standard				Option W30 (305mm)		
							High	Low					High	Low							
125kg	EQM001IS-IS				0.5		17.0	2.8	22.1									156kg	63		
250kg	EQM003IS-IS	C			40/20	10.0	1.7	13.0	5.6 x 1	M6/3m /H4	0.4	27/13	24	4	58-153	154-305	800 [3500]	313kg	64	0.71	
500kg	EQM005IS-IS		3	2.5		7.6	1.3	9.9													
1	EQM010IS-IS	D			1.5		7.1	1.2	9.2	7.1 x 1	M5/2m /H4							1.25	75	1.14	

Note: The minimum radius curve may depend on flange width. For further information, contact the nearest KITO dealer.
The high speed is preset to the maximum speed in KITO factory. The lifting speeds are adjustable between High and Low and the traversing speeds are adjustable from 2.4 to 24.

Dimensions (mm)

Capacity (t)	Product Code	Headroom C	D	b	d	e	e'	g	i	j	k	m	n	r	t
125kg	EQM001IS-IS	420	515	315	220	515	179	27	95	27	130	205	109	51	31
250kg	EQM003IS-IS														
500kg	EQM005IS-IS	440													
1	EQM010IS-IS	490	565					31		22					

With Plain Trolley

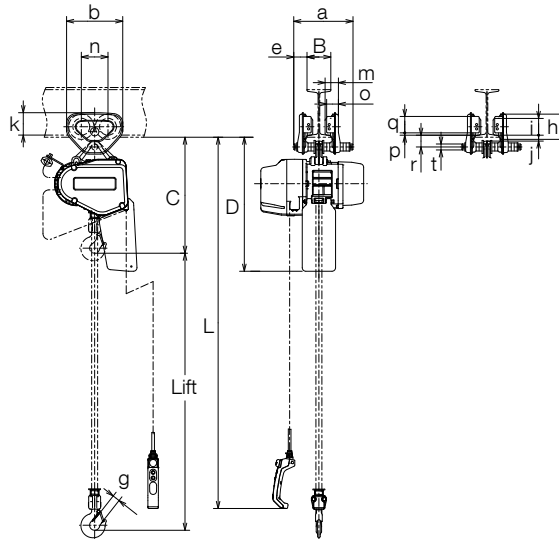

- Standard length of power supply cable is five meters.
- Optional length of lift, push button cord and power supply cable besides standard is available on your request.
- Extending the load chain is prohibited with additional links.

EQSP Specifications

Capacity (t)	Product Code	EQ										EQSP			Test Load (t)	Net Weight (kg)	Additional Weight per 1m Lift (kg)	
		Hoist Body	Standard Lift (m)	Push Button Cord L (m)	Lifting Motor		Lifting Speed (m/min)*			Load Chain	Classification ISO/FEM /ASME	Flange Width B (mm)						Min. Radius Curve (mm)
					Output (kW)	Rating (%ED)	50/60Hz					Standard	Option					
							High	Low	No load High speed				W20 (203mm)	W30 (305mm)				
125kg	EQSP001IS	C	3	2.5	0.5	40/20	17.0	2.8	22.1	5.6 x 1	M6/3m /H4	50-102	103-203	204-305	1100	156kg	34	0.71
250kg	EQSP003IS				0.75		7.6	1.3	9.9							625kg		
500kg	EQSP005IS				1.5		7.1	1.2	9.2							1300		
1	EQSP010IS	D														1.25	49	1.14

Note: The high speed is preset to the maximum speed in KITO factory. The lifting speeds are adjustable between High and Low.
 In case of only straight I-beam, 0.5ton plain trolley can be used on 57mm and less width beam and 1ton plain trolley and geared trolley can be used on 73mm and less width beam.

EQSP Dimensions (mm)

Capacity (t)	Product Code	Headroom C	D	a	b	e	g	h	i	j	k	m	n	o	p	q	r	t
125kg	EQSP001IS	415																
250kg	EQSP003IS		505	204	182	46	27	82	60	19	76	47.5	84	42	10	54	38	22
500kg	EQSP005IS	430																
1	EQSP010IS	490	565	249	236	56	31	106	71	25	95	56	112	50		69	50	25

Electric Chain Hoist (EQM) Rated Currents

For lifting

Type	Motor output (kW)	Rated current (A)			
		200-230 V		380-460 V	
		50Hz	60Hz	50Hz	60Hz
EQ001IS	0.5	5.1		2.8	
EQ003IS					
EQ005IS	0.75	6.3		3.3	
EQ010IS	1.5	10.5		5.5	

For traversing

Motor output (kW)	Rated current (A)			
	220-230 V		380-440 V	
	50Hz	60Hz	50Hz	60Hz
0.4	3.5		2.5	

Note: MR2Q is designed for 220-230V or 380-460V.

Power Supply Cable Allowable Lengths (EQ + MR2Q)

See the following table for the standard power supply cable allowable lengths and sizes. When using the cable of other size than those mentioned in the table, determine the cable length by the right formula.

$$\text{Allowable length (m)} = \frac{1000}{30.8} \times \frac{\text{Cross-sectional area of 1 core wire (mm}^2\text{)} \times \text{Rated voltage (V)} \times 0.02}{\text{Rated current (A)}}$$

Note: MR2Q is designed for 220-230V or 380-460V.

Type	Cable size (mm ²)	Single EQ				Cable size (mm ²)	EQM combined			
		Rated current (A)					Rated current (A)			
		200-230 V		380-460 V			220-230 V		380-440 V	
		50Hz	60Hz	50Hz	60Hz		50Hz	60Hz	50Hz	60Hz
EQ001IS	1.25	31		110		2	33		93	
EQ003IS		(50)		(176)			(58)		(162)	
EQ005IS	(2)	25		93		29		85		
EQ010IS		15		56		20		61		
		(24)		(89)		(35)		(107)		

Note: Parenthesized values denote the size one rank above the standard one.

For customers considering using the product with a 460V power supply, please contact the nearest KITO dealer.